

M1500-M4000 Series Parts List

Control Panel Components

<u>Part Number</u>	<u>Req'd</u>	<u>Description</u>
12A7500E07	1	SELECTOR SWITCH, 3-POSITION A/B
12A7500E05	1	SWITCH #11210007 TOGGLE DP-DT On-Off-Thaw Switch (Replaces On-Off on older models)
12A7500E08	1	SWITCH, TOGGLE, STEMCO #1145, Ice-Clean Switch (Also used as On-Off on older models)
12A2117G03	2	A/B THERMOSTAT, 6FT
12A2117G01	2	A/B THERMOSTAT, 15FT Optional
126114T		THERMOSTAT MOUNTING BRACKET
12A2117B01	1	LOW PRESSURE CONTROL 836L32
12633	1	HIGH PRESSURE CONTROL 836H33XNAS60
12A2117E01	2	FREEZER PRESSURE SWITCH-R12
12A2117F06	1	CONDENSER FAN CONTROL SWITCH Replaces Mercoid fan control #DA-34-3B
12D2590G09	1	GAGE, 2.5" LQD FILLED, 30"-400 Condenser Pressure Gage
126005	1	CONDENSER GAUGE BRACKET FOR 3" GAGE
12A7503E22	1	THAW TIMER, 8 PIN PLUG-IN, 100-240V., 50/60HZ Replaces all other timers (requires base below)
12A7503E2201	1	TIMER BASE #0T08-PC, EIGHT PIN PLUG-IN
12A7516E43	2	A/B CONTACTOR, 9-AMP, 4-POLE, 208/240V W/2-NO,2-NC Control Relay or Reversing Relay (Replaces 12A7517E08)
12A7518E30	1	A/B AUX. CONTACT, 3A, 1 NO/1 NC, (SIDE MOUNT)
12A7518E01		CONTACT CARTRIDGE 700-C1 FOR A/B N-TYPE RELAYS
12A7516E28	1	A/B CONTACTOR, 37-AMP, 3-POLE, 208/240V W/1-NO AUX. Compressor (C) or Control Contactor (CC) Replaces Furnas 12A7516E05
12A7516E11	1	CONTACTOR / CUTLER-HAMMER 10AMP, 3-POLE Air-Cooled Fan Contactor (Replaces Furnas 12A7516E01)
12A7515E01		CIRCUIT BREAKER 2.5 AMP,AIRPAX
12A7515E05		CIRCUIT BREAKER 3.0 AMP,AIRPAX
12A7515E07		CIRCUIT BREAKER 4.5 AMP,AIRPAX
12A7515E04		CIRCUIT BREAKER 5.0 AMP,AIRPAX
12A7515E17		CIRCUIT BREAKER 5.5 AMP, AIRPAX
12A7515E06		CIRCUIT BREAKER 6.0 AMP,AIRPAX

M1500-M4000 Series Parts List

Control Panel Components (Con'd)

<u>Part Number</u>	<u>Req'd</u>	<u>Description</u>
12A4000G0104	2	CIRCUIT BREAKER MOUNTING BRACKET
12A7502E07	1	FUSE HOLDER,LITTEL FUSE SHOCK
12A7504E08	2	FUSE 1 AMP 250V 1/4 X 1 1/4 GL <i>(Control Circuit Fuse, order in multiples of 5)</i>
12A7504E09	2	FUSE 2 AMP.250V.,1/4"D X 1 1/4 <i>(Control Circuit Fuse, order in multiples of 5)</i>
12A7519E03	1	CONTROL CIRCUIT TRANSFORMER, 460V-230V, 1KVA <i>Water-Cooled Units</i>
12A7519E04	1	CONTROL CIRCUIT TRANSFORMER, 460V-230V, 1-1/2 KVA <i>Air-Cooled Units</i>
12A7516E11	1	CONTACTOR / CUTLER-HAMMER 10AMP, 3-POLE <i>Power Failure Relay or Compressor Delay Relay</i>
12A7500E17	1	C/H PUSH-BUTTON SWITCH (GREEN) W/START NAMEPLATE
12A7518E03	1	C/H CONTACT BLOCK FOR PUSH-BUTTON SW (1-N/O,1-N/C)
12A7503E12	1	COMPRESSOR DELAY TIMER, ICM #BMS230A1X5, 230VAC

Freezer Components

<u>Part Number</u>	<u>Req'd</u>	<u>Description</u>
251901B	1	FREEZER ASSEMBLY FOR M1500, INSULATED & CRATED <i>Shipping weight approximately 360lbs</i>
251902B	1	FREEZER ASSEMBLY FOR M1800/3000, INSUL. & CRATED <i>Shipping weight approximately 370lbs</i>
251903B	1	FREEZER ASSEMBLY FOR M2500, INSULATED & CRATED <i>Shipping weight approximately 440lbs</i>
251904B	1	FREEZER ASSEMBLY FOR M4000, INSULATED & CRATED <i>Shipping weight approximately 450lbs</i>
12A2760F		INSULATION ENSOLITE (PER LINEAR FT-60" LONG)
12A2600G01	1	FREEZER COVER GASKET 13" OD X 11 11/16" ID X 3/16"
12A2145C09	1	COVER, FREEZER, 12" TYPE 304 CAST STAINLESS STEEL
12A2222H1118	8	STUD BOLT, 3/8"-16NC X2 3/4"LG
12A2240H4109	8	NUT, WING, BRASS, 3/8"-16NC
12A2250A109	8	WASHER, CUT 3/8" x 7/8" O.D. SS
12A4200L0401	1	RELIEF VALVE #3020 SET @ 235#, 1/2" MPT x 5/8" SAE
12B2185N11	78	1" WATER DISTRIBUTOR SANOPRENE NO VENT <i>For 1" tube M1800/3000/4000</i>
12B2185N31	36	1-1/2" WATER DISTRIBUTOR SANOPRENE NO VENT <i>For 1-1/2" tube M1500/2500</i>
12A2055B02		BRUSH, STAINLESS STEEL #GTC210 FOR 1" TUBES
12A2055B03		BRUSH, STAINLESS STEEL FOR 1-1/2" TUBE

M1500-M4000 Series Parts List

Freezer Components (Con'd)

<u>Part Number</u>	<u>Req'd</u>	<u>Description</u>
12A4009R01		PLUG, RUBBER 7/8" OD X 2" LG FOR 1" TUBES
12A2215H1116	1	CAP SCREW, 3/8"-16NC X 2-1/4" LONG <i>(Use this bolt for 1" tubes)</i>
12A2250A109	2	WASHER, CUT 3/8" x 7/8" O.D. SS <i>(Use this washer for 1" tubes)</i>
12A4009R02		PLUG, RUBBER 1"OD X 2 1/2"LG FOR 1-1/4" TUBES
12A4009R03		PLUG, RUBBER 1 1/4"OD X 2 1/2" FOR 1-1/2" TUBES
12A2215H1119	1	CAP SCREW, 3/8"-16NC X 3" LONG <i>(Use this bolt for 1-1/4" or 1-1/2" tubes)</i>
12A2250A12	2	WASHER, CUT 3/8" x 1" O.D. SS <i>(Use this washer for 1-1/4" or 1-1/2" tubes)</i>
12A2240A1109	1	NUT, HEX 3/8"-16NC S.S.

Compressors / Components

<u>Part Number</u>	<u>Req'd</u>	<u>Description</u>
12A2110A22	1	CARLYLE SEMI-HERMETIC COMPRESSOR-2HP 208/230V-3P <i>M1500 & 1800 Models, 208/230V-3P-60HZ</i>
12A2110A24	1	CARLYLE SEMI-HERMETIC COMPRESSOR-2HP 400/460V-3P <i>M1500 & 1800 Models, 460V-3P-60HZ or 380/400V-3P-50HZ</i>
12A2110A32	1	CARLYLE SEMI-HERMETIC COMPRESSOR-5HP 208/230V-3P <i>M2500 & 3000 Models, 208/230V-3P-60HZ or 200V-3P-50HZ</i>
12A2110A34	1	CARLYLE SEMI-HERMETIC COMPRESSOR-5HP 400/460V-3P <i>M2500 & 3000 Models, 460V-3P-60HZ or 380/400V-3P-50HZ</i>
12A2110A42	1	CARLYLE SEMI-HERMETIC COMPRESSOR-6.5HP 208/230V-3P <i>M4000 Models, 208/230V-3P-60HZ or 200V-3P-50HZ</i>
12A7509E09	1	CRANKCASE HEATER #14SS-5358-23-54C42, 65 WATT <i>M1800/1800/2500/3000 Compressor</i>
12A7509E02	1	CRANKCASE HEATER 180 WATT, INSERTION <i>M4000 Compressor</i>
12A7509F01	1	RETAINER RING FOR INSERTION HEATER
12A7509F02	1	THERMAL GREASE PACKET
12A2110P0201		COMPRESSOR VALVE PLATE PKG FOR CARLYLE O6D <i>M1500/1800 - 1 Req'd, M2500/3000 - 2 Req'd, M4000 - 3 Req'd</i>
12A2110P0215	1	CARLYLE COMPRESSOR PUMP END BEARING HEAD ASSY
126608	1	GASKET SET FOR CARLYLE O6D COMPRESSOR
12A7523E01	2	OVERLOAD KLIXON 8347A23-54 <i>M1500/1800, 208/230V</i>
12A7523E03	2	OVERLOAD KLIXON 8347A23-63 <i>M2500/3000, 208/230V</i>

M1500-M4000 Series Parts List

Compressors / Components (Con'd)

<u>Part Number</u>	<u>Req'd</u>	<u>Description</u>
12A4200S05	1	CARLYLE SERVICE VALVE, 5/8" ODS <i>Discharge Service Valve for M1500/1800</i>
12A4200S07	1	CARLYLE SERVICE VALVE, 7/8" ODS <i>Suction Service Valve for M1500/1800 or Discharge Service Valve for M2500/3000/4000</i>
12A4200S09	1	CARLYLE SERVICE VALVE, 1-1/8" ODS <i>Suction Service Valve for M2500/3000</i>
12A4200S11	1	CARLYLE SERVICE VALVE, 1-3/8" ODS <i>Suction Service Valve for M4000</i>
126609		CARLYLE SERVICE VALVE GASKET <i>M1500/1800-Suction & Discharge, M2500/3000/4000 Discharge</i>
12661		CARLYLE SERVICE VALVE GASKET <i>M2500/3000 - Suction</i>
126611		CARLYLE SERVICE VALVE GASKET <i>M4000 - Suction</i>

Cutter Drive/Cutter Internals

<u>Part Number</u>	<u>Req'd</u>	<u>Description</u>
12A2900M0507	1	CUTTER MOTOR, 1/2HP 208/230V-1P-50/60HZ <i>Replaces 1/4HP motor (Requires 5.5 amp Circuit Breaker)</i>
12A4030R12	1	GEAR REDUCER, GROVE 10:1 WASHDOWN W/VENT PLUG
19T3020C01	1	GEAR OIL, 10 OUNCE BOTTLE, TEXACO CYGNUS
19T2615D01	1	CUTTER DRIVE GEAR TI-59 W/O HUB
12A2160H0101	1	CUTTER DRIVE GEAR HUB 5/8" BORE
12A2215F1112	3	CAP SCREW, 1/4"-20NC X 1 1/4" Long SS <i>Hub mounting screws</i>
12A2250B107	3	WASHER, LOCK 1/4" SS (300 SERIES)
12B2020R01	1	UHMW CUTTER BEARING FOR M1500 thru P418F
12A3040S02	1	CUTTER BEARING ROLL PIN 3/16" X 1/2"
19T2025B0103	1	BEARING BRACKET FOR 12" CUTTER <i>Short style for HE, 12A2020R01 bearing is long but will work Ice deflector must be modified to fit in bracket</i>
126431	1	DEFLECTOR PLATE FOR M1500 THRU 4000
126433	1	DEFLECTOR ACTIVATING ROD FOR M1500 THRU 4000
251607	1	ICE CHUTE ASSEMBLY FOR M1500-4000
12A4071S03	1	RIVET, 3/16 X 2 1/4 FLAT HD. FOR ICE DELECTOR DOOR
19T2163D0101	1	CUTTER DISC, STAINLESS STEEL FOR 12" CUTTER
12A3040S01	1	CUTTER DISC ROLL PIN, 1/4" X 1 1/2"
19T4073R07	1	CUTTER DISC ROLL PIN TOOL
126645	1	DRIVE GEAR ENCLOSURE M1500-4000
126411	1	CUTTER ASSEMBLY 12" REVERSIBLE W/SHAFT & RING GEAR

M1500-M4000 Series Parts List

Cutter Drive/Cutter Internals (Con'd)

<u>Part Number</u>	<u>Req'd</u>	<u>Description</u>
12A2005A01	1	PLATE ADAPTOR KIT FOR 1" ICE M1500/2500 <i>(Includes spacers, nuts & bolts below)</i>
12A4130S02	3	SPACER, ADAPTOR PLATE, 5/8"OD x 3/8" LONG
12A2226F1109	3	MACHINE SCREW, FLAT HEAD SS, 1/4" x 7/8"
12A2240A1307	3	NUT, HEX 1/4"-20NC S.S.
12A2250B107	3	WASHER, LOCK 1/4" SS (300 SERIES)
12A2005A02	1	PLATE ADAPTOR KIT FOR 3/4 ICE M1800/3000/4000 <i>(Includes spacers, nuts & bolts below)</i>
12A4130S01	2	SPACER, ADAPTOR PLATE, 5/8"OD x 1/8" LONG
12A4130S03	2	SPACER, ADAPTOR PLATE, 5/8"OD x 5/8" LONG
12A2226F1108	2	MACHINE SCREW, FLAT HEAD SS, 1/4" x 3/4"
12A2226F1112	2	MACHINE SCREW, FLAT HEAD SS, 1/4" x 1-1/4"
12A2240A1307	4	NUT, HEX 1/4"-20NC S.S.
12A2250B107	4	WASHER, LOCK 1/4" SS (300 SERIES)

Water Pump/Circulating Water

<u>Part Number</u>	<u>Req'd</u>	<u>Description</u>
12A4200H0201	1	FLOAT VALVE, 1/4" ROBERTS #RM150-10
12A4020Z16	1	M1500-4000 WATER PUMP REPLACEMENT KIT, 60HZ <i>Replaces ALL pumps, includes pump, fittings, bracket & hoses</i>
12A4020Z17	1	M1500-4000 WATER PUMP REPLACEMENT KIT, 50HZ <i>Replaces ALL pumps, includes pump, fittings, bracket & hoses</i>
12A4080S21	1	SEAL/IMPELLER KIT 60HZ GORMAN-RUPP WATER PUMP
12A4080S22	1	SEAL/IMPELLER KIT 50HZ GORMAN-RUPP WATER PUMP
12A2450E29	1	SUCTION ELBOW FOR GORMAN-RUPP WATER PUMP
12A2450E30	1	DISCHARGE ELBOW FOR GORMAN-RUPP WATER PUMP
12A2450E31	1	ELL FOR BLOWDOWN TUBING, 1/4" MPT X 1/4" TUBING
12A2450A26	1	PUMP DISCHARGE FITTING 1" MPT X 1 1/4" BARBED INSERT
12A2450C10	1	PUMP SUCTION TUBING ADAPTOR 1 1/4" X 1" BARBED FITTING
12A4200G0501	1	ANGLE VALVE, SUPERIOR 5/8" ODC
12A4181T11	4	TUBING, POLYETHYLENE 1/4OD X .170" ID <i>Blowdown tubing (40" required) (Sold per ft.)</i>
12A4181T05	1	TUBING, TYGON B-44-3, 1-1/2" OD x 1" ID <i>Pump Suction tubing (20" required) (Sold per ft.)</i>
12A4080S04	1	SEAL ASSEMBLY #397012 FOR A/P PUMP
126628AP	1	PUMP HOUSING O-RING #391015 FOR A/P PUMP
12A4020Y02	1	PUMP, IMPELLER #391046 FOR A/P PUMP 60HZ (12A4020A06)
12A4020Y04	1	PUMP, IMPELLER #391531 FOR A/P PUMP 50HZ (12A4020A07)
12A4080S05	1	PUMP SEAL, #PS-164 FOR GUSHER 1/3HP PUMP
126628G	1	GASKET 6053G FOR GUSHER PUMP
12A2600G03	1	PUMP SUCTION GASKET, 7 1/2" x 4 1/2" x 3/16" <i>For sidewall mounted pumps</i>
12A4080S01	1	SEAL, ASSY US #PS-877 FOR AURORA 320 SERIES
12A2600G02	1	WATER TANK GASKET 15 3/4" O.D. x 13 3/4" I.D.
12A4181T06	5FT	TUBING, TYGON B-44-3, 1-1/2" OD x 1-1/4" ID <i>Circulating Water Tubing (priced per foot)</i>

M1500-M4000 Series Parts List

Water Pump/Circulating Water (Con'd)

<u>Part Number</u>	<u>Req'd</u>	<u>Description</u>
12A4181T05	1	TUBING, TYGON B-44-3, 1-1/2" OD x 1" ID Pump Suction Tubing (priced per foot)
12A4181T01	1	TUBING, TYGON B-44-3, 7/8" OD x 5/8" ID Water Tank Drain Tubing (priced per foot)
12A4181T08	3	TUBING, TYGON B-44-3, 3/8" OD x 1/4" ID Blowdown Tubing (priced per foot)
12A2100C0201		CLAMPS, SS HOSE, 13/16" x 1 3/4"
12A4200G0101	1	PET COCK VALVE, 1/8" MPT x 1/4" HOSE

Condenser-Receiver

Note: Shell & Coil Condenser-Receiver no longer manufactured.

<u>Part Number</u>	<u>Req'd</u>	<u>Description</u>
12A2115S0401	1	CONDENSER, STANDARD KH2X, 8710 M1500 & M1800
12A2115S0301	1	CONDENSER, STANDARD QC3X #8710-41 M2500 & M3000
12A2115S0201	1	CONDENSER, STANDARD QC5X #8710-43 M4000
12A2055B01	1	CONDENSER CLEANING TOOL, ADJUSTABLE 3/8" x 1/2" ID
12659623	1	GASKET SET-K2X, KH2X & K3X "STANDARD" CONDENSER M1500 & M1800 (12-1/2" x 4-1/2")
1265961	1	GASKET SET-K10X, KH10X, QC3X & QC5X "STANDARD" COND. M2500, M3000, M4000 (16" x 5-1/2")
12A4200E0403	1	WATER REGULATING VALVE, 1/2" M1500/1800/2500/3000
12A4200E0802	1	WATER REGULATING VALVE, 1" FPT M4000
12A4200E0402	1	WATER REGULATING VALVE, 1/2" HP M1500/1800/2500/3000 High pressure (above 90 psi)
12A4200E0801	1	WATER REGULATING VALVE, 1" METREX M4000 High pressure (above 90 psi)
12A2625G01	1	GAGE GLASS 1/2" X 10-3/16" LONG For Brass Valves M1500/1800/3000
12A2625G0101	1	GAGE GLASS 1/2" X 11 5/16" LONG For Steel Valves M1500/1800/3000
12A2625G06	1	GAGE GLASS 1/2" X 15-1/8" LONG For Brass Valves M2500 & M4000

M1500-M4000 Series Parts List

Condenser-Receiver (Con'd)

<u>Part Number</u>	<u>Req'd</u>	<u>Description</u>
12A2625G0601	1	GAGE GLASS 1/2" X 16-1/4" LONG <i>For Steel Valves M2500 & M4000</i>
12A4200J0405	1	UPPER GAGE COCK VALVE, HENRY 1/2" FPT <i>Replaced Brass Valve 12A4200J0403 - May 1999</i>
12A4200J0406	1	LOWER GAGE COCK VALVE, HENRY 1/2" FPT <i>Replaced Brass Valve 12A4200J0404 - May 1999</i>
12A3050C0301	2	PIPE NIPPLE, 1/2" X 1-1/2" LONG
12A2635G01	1	GUARD SET 8 3/4" LONG GALV. <i>Use with 10-3/16" glass</i>
12A2635G02	1	GAGE GLASS, GUARD SET 14" LG <i>Use with 15-1/8" glass</i>
19T2635G07	1	GAGE GLASS GUARD SET, 18 5/8" <i>Use with new steel valves (cut to fit)</i>
12A4199V26	2	GAGE GLASS PACKING O-RING FOR 1/2" DIAMETER
12A4200L0401	1	RELIEF VALVE #3020 SET @ 235#, 1/2" MPT x 5/8" SAE
12A4200G0401	1	ANGLE VALVE, 1/2" MPT x 1/2" ODC <i>Liquid Outlet Valve (King Valve)</i>
12A4200G0201	1	VALVES, 1/4" MPT X 1/4" SAE <i>Receiver Drain Valve</i>

Air-Cooled Condenser

<u>Part Number</u>	<u>Req'd</u>	<u>Description</u>
12A2115KS041	1	CONDENSER, HDD-41, 50/50 SPLIT COIL SINGLE PHASE <i>M1500 & M1800</i>
12A2115KS061	1	CONDENSER, HDD-61, 50/50 SPLIT COIL SINGLE PHASE <i>M2500 & M3000</i>
12A2115KS101	1	CONDENSER, HDD-101, 50/50 SPLIT COIL SINGLE PHASE <i>M4000</i>
12A2900M0401	1	MOTOR 1/3HP GE#5KCP35MN34GS (KRAMER 049-161) <i>HDD-61 (M2500 & M3000)</i>
12A2900M0506	2	MOTOR, 1/2HP, 208/230-1-60HZ, (KRAMER 049-158) <i>HDD-101 (M4000)</i>
12A2115P0301	1	CONDENSER, FAN BLADE 039-193, 30" <i>HDD-61 (M2500 & M3000)</i>
12A2115P0401	2	CONDENSER, FAN BLADE 213455000, 24" <i>HDD-101 (M4000)</i>

M1500-M4000 Series Parts List

Water-Cooled to Air-Cooled Conversion

<u>Part Number</u>	<u>Req'd</u>	<u>Description</u>
12A7516E09	1	CONTACTOR / CUTLER-HAMMER 2-POLE, 10AMP
12A2117F06	1	CONDENSER FAN CONTROL SWITCH
12A4200A0504	1	SOLENOID VALVE, 5/8" ODF SPORLAN ME14S <i>Discharge Line Solenoid (X) for M1500 & M1800</i>
12A4200A0707	1	7/8" SOLENOID VALVE, SPORLAN MB25 W/COIL <i>Discharge Line Solenoid (X) for M2500/3000/4000</i>
12A4200B0501	1	CHECK VALVE, 5/8" O.D. <i>Liquid Return for M1500 & M1800</i>
12A4200B0701	1	CHECK VALVE, 7/8" O.D. <i>Liquid Return for M2500/3000/4000</i>

Liquid Line

<u>Part Number</u>	<u>Req'd</u>	<u>Description</u>
12A4200C0401	1	EXPANSION VALVE, #TCL3FW GT-3273, 1/2"ODF x 5/8" ODF <i>M1500 & M1800</i>
12A4200C0501	1	EXPANSION VALVE, PF12C (REPLACES PF7-1/2C) <i>M2500/3000/4000</i>
12A4200A0411	1	1/2" SOLENOID VALVE, SPORLAN MB9 W/COIL <i>Liquid Line Solenoid (A) (Standard Length)</i>
12A2105C16	1	COIL, #MKC-2 FOR SPORLAN 208/240V-50/60HZ
12A4199V37	1	REPAIR KIT #KSB9/E9 FOR SPORLAN ME9S
126232RB	1	COIL #R-23MM W/HOUSING 208/240 for JACKES-EVANS
12A4199V02	1	REPAIR KIT #76750 FOR JE #RB9MS4 (1/2") VALVE
126232	1	COIL 3MP-23MM #75070 W/HOUSING FOR JACKES-EVANS
12A4199V01	1	REPAIR KIT #76640 FOR JE #B3 VALVE
12A4200G0401	1	ANGLE VALVE, 1/2" MPT x 1/2" ODC <i>Liquid Outlet Valve (King Valve)</i>
12A2195D01	1	DRIER, EK-164, 1/2" SAE <i>M1500 & M1800</i>
12A2195D02	1	DRIER, SPORLAN #C304, 1/2" SAE <i>M2500/3000/4000</i>
12A2710H04	1	HEAT-EXCHANGER DOUCETTE 1-1/8" x 1/2"

M1500-M4000 Series Parts List

Thawing Gas Line

<u>Part Number</u>	<u>Req'd</u>	<u>Description</u>
12A4200A0501	1	SOLENOID VALVE, SPORLAN #MB19S2, 5/8" ODC <i>Thawing gas solenoid (D) (Used on early M1500 & M1800)</i> <i>(Replaces 3MS & B4MS5)</i>
12A4200A0707	1	7/8" SOLENOID VALVE, SPORLAN MB25 W/COIL <i>Thawing gas solenoid (D) (Replaces 6MS, DS8000, B6MS</i> <i>& B6MS7 and RB21MS7</i>
12A2105C16	1	COIL, #MKC-2 FOR SPORLAN 208/240V-50/60HZ
12A4199V39	1	REPAIR KIT #KSB25/E25 FOR SPORLAN ME25S
126232RB	1	COIL #R-23MM W/HOUSING 208/240 for JACKES-EVANS
12A4199V07	1	REPAIR KIT #76754 FOR JE #RB21MS7 (7/8") VALVE
126232	1	COIL 3MP-23MM #75070 W/HOUSING FOR JACKES-EVANS
12A4199V01	1	REPAIR KIT #76640 FOR JE #B3 VALVE
12A4199V04	1	REPAIR KIT #76641 FOR JE #B4 (1/2") VALVE
12A4199V06	1	REPAIR KIT #76642 FOR JE #B6 VALVE

Ice Spreader

<u>Part Number</u>	<u>Req'd</u>	<u>Description</u>
12A2900M0201	1	MOTOR, 1/10HP, 208-230, 1P, 60HZ #
12A4099S01	1	SHEAVE, 1.5" V-BETL (CONGRESS)
12A4099S02	1	SHEAVE, 4.5" V-BELT (CONGRESS)
12A2030B01	1	BELT, #3L270 V-BELT (27" LONG)
251607SSH25	1	ICE SPREADER SHAFT, 5/8" O.D. x 25" LONG
12A2020M01	1	BEARING, PART #SSR8-2RS 1/2" B
12A4135PS05	1	SPREADER, BEARING MOUNTING BRA
12A2020M06	1	BEARING, POBCO #BBU-10-SS TRIM
12A4135PS07	1	ICE DISTRIBUTOR (MODIFIED 6" TEE)
12A2032B08	1	BINMASTER, CONTROL, BINDICATOR
12A2032B06	1	BINMASTER, PADDLE PART #730-0005 SS
12A2032B05	1	BINMASTER MOUNTING FLANGE, SS WITH GASKET
12A2476T0401	1	COUPLING SHAFT (1/4" PIPE COU
12A7500E2	2	SWITCH CHERRY #E72-40A SPDT WA

M1500-M4000 Series Parts List

Miscellaneous

<u>Part Number</u>	<u>Req'd</u>	<u>Description</u>
252705	1	FRONT CASING FOR M1500, M1800 OR M3000
252706	1	FRONT CASING FOR M2500 OR M4000

Goldenrod Water Treatment

<u>Part Number</u>	<u>Req'd</u>	<u>Description</u>
12A2195W0501	1	GOLDENROD WATER TREATMENT, 5" - 13 GPM - NSF
12A2195W0502	1	REPLACEMENT GOLDENROD CELL, 5"
12A2195I01	2	INSULATOR, DELRON FOR 5", 9", OR 12" GOLDENROD
12A2195W0504	1	DELRON THREADED PLUG FOR GOLDENROD

Contactor/Relay Cross Reference

Furnas						Cutler-Hammer						Allen Bradley					
Contactor			Aux Contacts			Contactor			Aux Contacts			Contactor			Aux Contacts		
Vogt #	Furnas #	Desc	Vogt #	Furnas #	Desc	Vogt #	Cutler-Hammer #	Desc	Vogt #	Cutler-Hammer #	Descr	Vogt #	Allen Bradley #	Desc	Vogt #	Allen Bradley #	Descr
12A7516E01	45CA20AG	2 pole 20 Amp	N/A	N/A	N/A	12A7516E09	CE15BNY1	2 pole 10 Amp	N/A	N/A	N/A	12A7516E23	100-C09L10	3 pole (N.O. aux) 9 Amp	N/A	N/A	N/A
N/A	N/A	N/A	N/A	N/A	N/A	12A7516E10	CE15ENY1	3 pole 25 Amp	12A7518E15	C320KGS3	1-N.C. / 1-N.O.	12A7516E26	100-C23L01	3 pole (N.C. aux) 23 Amp	12A7518E30	100-SA11	1-N.C. / 1-N.O.
N/A	N/A	N/A	N/A	N/A	N/A	12A7516E13	CE15DN3Y2BB	3 pole 18 Amp	12A7518E20	C320KGS2	1-N.C.	12A7516E26	100-C23L01	3 pole (N.C. aux) 23 Amp	N/A	N/A	N/A
N/A	N/A	N/A	N/A	N/A	N/A	12A7516E14	CE15NN3B	3 pole 140 Amp	N/A	N/A	N/A	12A7516E31	100-B110NL3	3 pole 110 Amp	12A7518E34 12A7518E35	195-GA11 195-GA20	1 - N.O./1-N.C. 2 - N.O.
12A7516E03	40FP32AA	3 pole with 1 N.O. aux contact	12A7518E04 12A7518E14	49AAFO 49AAFC	1- N.O. (2 Req) 1-N.C.	* 12A7516E16	CE15HN3BB	3 pole 44 Amp	12A7518E15 12A7518E16	C320KGS3 C320KGS4	1- N.O./1-N.C. 2-N.O.	12A7516E29	100-C43L10	3 pole (N.O. aux) 43 Amp	12A7518E30 12A7518E31	100-SA11 100-SA20	1- N.O./1-N.C. 2 - N.O.
12A7516E05	42BF25AG (42BE25AG)	4 pole 30 Amp Definite Purpose	12A7518E08 12A7518E09	49D22125001 49D22125002	1- N.O. 1-N.C.	**12A7516E17	C25END430B	4 pole 30 Amp Definite Purpose	12A7518E15	C320KGS3	1- N.O./1-N.C.	12A7516E28	100-C37L10	3 pole (N.O. aux) 37 Amp	12A7518E30	100-SA11	1- N.O./1-N.C.
12A7516E02	41NB20AGM	2 pole 25 Amp Definite Purpose	N/A	N/A	N/A	12A7516E18	C25DND325B	3 pole 25 Amp Definite Purpose	N/A	N/A	N/A	12A7516E26	100-C23L01	3 pole (N.C. aux) 23 Amp	N/A	N/A	N/A
12A7516E06	41NB30AGM	3 pole 25 Amp Definite Purpose	N/A	N/A	N/A	12A7516E18	C25DND325B	3 pole 25 Amp Definite Purpose	N/A	N/A	N/A	12A7516E26	100-C23L01	3 pole (N.C. aux) 23 Amp	N/A	N/A	N/A
N/A	N/A	N/A	N/A	N/A	N/A	12A7516E22	CE15KN3B	3 pole 73 Amps	12A7518E15 12A7518E16 12A7518E21	C320KGS3 C320KGS4 C320KGT4	1- N.O./1-N.C. 2-N.O. (side) 2-N.O. (top)	12A7516E30	100-C72L00	3 pole 72 Amps	12A7518E30 12A7518E31 12A7518E32	100-SA11 100-SA20 100-FA20	1- N.O./1-N.C. 2 - N.O. (side) 2 - N.O. (top)
12A7517E15	46US22G	2 N.O. 2 N.C.	N/A	N/A	N/A	12A7517E18	D15CRY1	2 N.O. 2 N.C.	N/A	N/A	N/A	12A7516E43	100-C09L200	2 N.O. 2 N.C.	N/A	N/A	N/A
12A7517E16	46US31G	3 N.O. 1 N.C.	N/A	N/A	N/A	12A7517E20	D15CRY3	3 N.O. 1 N.C.	N/A	N/A	N/A	12A7516E43	100-C09L200	2 N.O. 2 N.C.	12A7518E30	100-SA11	1-N.C. / 1-N.O.

Note: * Contactor structured with Aux Contacts (CH#: C320KGS3 - 1 N.O. / 1 N.C. and CH#: C320KGS4 - 2 N.O.)

** Contactor structured with Aux Contact (CH#: C320KGS3 - 1 N.O. / 1 N.C.)

Revision: 2/15/99

Model 9000 - compressor contactor - Allen Bradley 702D0H93 has replaced with 500D0H930 (NEMA 3)

Where Used Listing - Contactors/Relays

Vogt # (Furnas)	Where Used	Notes	Vogt # (Cutler-Hammer)	Vogt # (Allen-Bradley)
12A 7516E01	Fan Contactor - M1500-M4000, HE B-series, HE C-series Power Failure - M1500-M4000, HE B-series Pump Contactor - HE C-Series Cutter Contactor - HE C-Series Bin Control - (B)P118F / P218F Power Failure - (B)P118F / P218F, (C)P118F, P18XT, P112F	12A7516E11 (3 pole) can be used	12A 7516E09	12A7516E23
N/A	Fan Contactor - (B)P118F, (C)P118F, P18XT, P112F	Requires 1 N.C. / 1 N.O. Aux Contact	12A 7516E10	12A7516E26
N/A	Compressor Contactor - HE C-series	Requires 1 N.C. Aux Contact	12A 7516E13	12A7516E26
N/A	Compressor Contactor - HES-series		12A 7516E13	12A7516E26
N/A	Compressor Contactor - P18XT	Requires 1 N.C. / 1 N.O. Aux Contact and 2 N.O. Aux Contact (side mount) and 2 N.O. Aux Contact (top mount)	12A 7516E14	12A7516E31
12A 7516E03	Compressor Motor Contactor - M6000-M9000, (B)P118F / P218F	Requires 3 N.O. - 1 N.C. Aux Contact	12A 7516E16	12A7516E29
12A 7516E05	Compressor Contactor - HE B-series Control Contact - HE B-Series * Control Contact - M1500-M4000, M6000-M9000 Compressor Contactor - M1500-M4000	Requires 1 N.C. / 1 N.O. Aux Contact Requires 1 N.O. Aux Contact No Aux Contact Required No Aux Contact Required	12A 7516E17	12A7516E28
12A 7516E06	Fan Contactor - Old (B)P118F / P218F (3 pole)	Definite Purpose contact	12A 7516E18	12A7516E26
12A 7516E02	Fan Contactor - M6000-M9000 (2 pole)			
12A 7517E15	Reversing Relay - M1500-M9000, HE B-series, HE C-Series, HE S-Series Control Relay - (B)P118F / P218F, (C)P118F, P18XT, P112F		12A 7517E18	12A7516E43
12A 7517E16	Control Relay - M1500-M9000, HE B-series (3 N.O./1 N.C.) Control Contact - M1500-M4000, M6000-M9000 (3 N.O.)	Stock Potter/Brumfield for M-series machine (12A7517E08)	12A 7517E20	12A7516E43
N/A	Compressor Contactor - (C)P118F, P112F	Requires 1 N.C. / 1 N.O. Aux Contact and 2 N.O. Aux Contact (side mount) and 2 N.O. Aux Contact (top mount)	12A 7516E22	12A7516E30

*Note: Stock Potter/Brumfield for direct replacement

Revision: 7/9/98

Gage Cock Valves / Sightglass / Gage Guards

Date: 10/06/99

	Machine	Old		New	
Valve	All Machines	12A4200J0403	Upper Valve (# 6022)	12A4200J0405	Upper Valve (# 5022)
		12A4200J0404	Lower Valve (# 6021)	12A4200J0406	Lower Valve (# 5021)
Gage Glasses & Guards	HE, P112, P118	12A2625G08	Glass - 18 7/8" (PS95-127)	12A2625G10	Glass - 20"
		12A2635G07	Guard - 17 5/8" (PS94-126) / (set of 2)	19T2635G07	Guard - 18 5/8" / (set of 2)
	P18XT	12A2625G02	Glass - 27 1/8"	12A2625G11	Glass - 28 3/8"
		12A2635G06	Guard - 28" (PS94-209) / (set of 2)	19T2635G06	Guard - 27 1/4" / (set of 2)
	P24, P34	12A2625G05	Glass - 29"	12A2625G11	Glass - 28 3/8"
		12A2635G06	Guard - 28" (PS94-209) / (set of 2)	19T2635G06	Guard - 27 1/4" / (set of 2)
	1500, 1800, 3000	12A2625G01	Glass - 10 3/16"	12A2625G0101	Glass - 11 5/16"
		12A2635G01	Guard - 8 3/4" / (set of 2)	19T2635G07	Guard - 18 5/8" (Cut to 10 3/16" / (set of 2))
	2500, 4000, 6000, 7000, 9000	12A2625G06	Glass - 15 1/8"	12A2625G0601	Glass - 16 1/4"
		HE's before 1991	12A2635G02	Guard - 13 3/4" (PS94-97) / (set of 2)	19T2635G07

Note: If changing from the old style valve to the new gage valve, a 1/2"X1 1/2" (12A3050C0301) pipe nipple must be used to connect the valve to the receiver
 12A2635G06 - Gage Guard 60"length # PS94-342 (was 28")

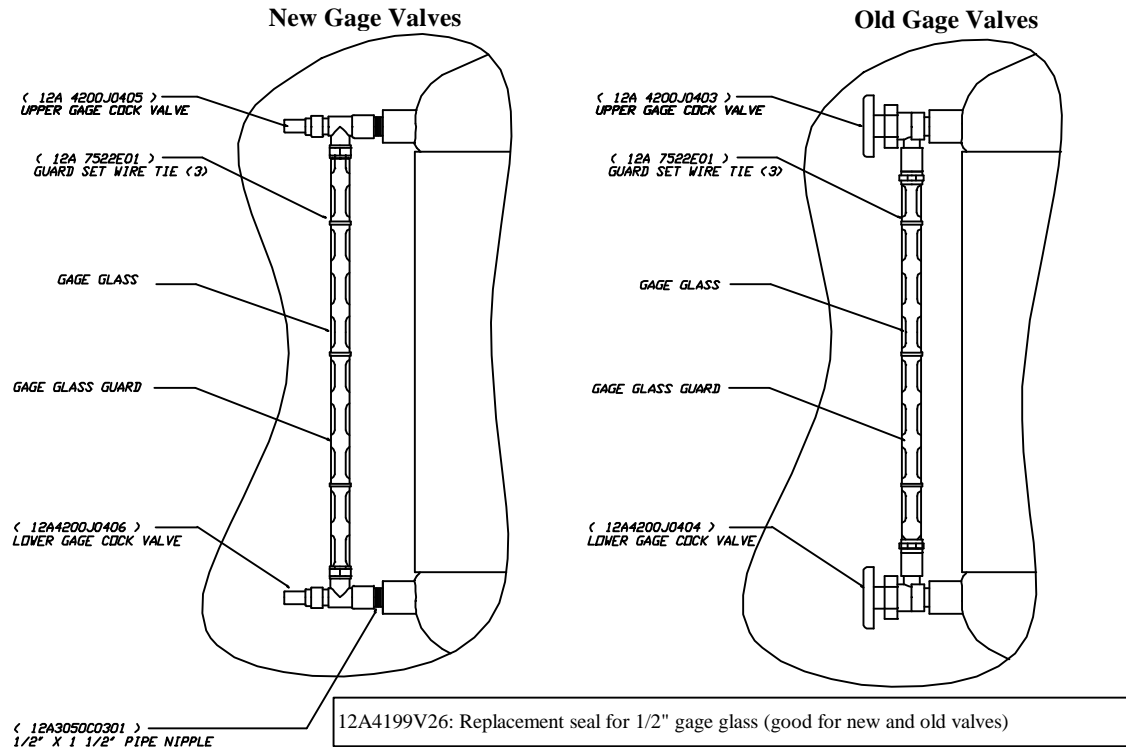

Cross Reference

Revision Date: 7/14/98

Solenoid Valves

		Jakes-Evans				Sporlan			
		Valve		Rebuild Kit		Valve		Rebuild Kit	
Where Used	Size	Vogt Part #	Model #	Vogt #	Part #	Vogt Part #	Model #	Vogt #	Part #
X-valve (P18F's)	1 5/8"	N/A	N/A	N/A	N/A	12A 4200A1103	ME42S2130	12A 4199V28	KS-E42
Kramer Air cooled condenser - HDD-590 (Normally Open)	1 5/8"	N/A	N/A	N/A	N/A	12A 4200A1104	OE42S2130	12A 4199V47	KS-OE42
Kramer Air cooled condenser - HDD-311 & 361 (Normally Open)	1 3/8"	N/A	N/A	N/A	N/A	12A 4200A1102	OE34S2110	12A 4199V45	KS-OE34
D-valve (B-Series P118F's)	1 3/8"	N/A	N/A	N/A	N/A	12A 4200A1101	ME42S2110-20	12A 4199V28	KS-E42
Kramer Air cooled condenser - HDD-131 (Normally Open)	1 1/8"	N/A	N/A	N/A	N/A	12A 4200A0902	OE34S290	12A 4199V45	KS-OE34
SS-valve (HES) with bypass									
X-valve (B-Series P118F's)	1 1/8"	12A 4200A0901	RB41MS9	12A 4199V10	76757	N/A	N/A	N/A	N/A
X-valve (C-Series P118F's)	1 1/8"	12A 4200A0903	RB41ME9	12A 4199V10	76757	12A 4200A0904	ME34S290	12A 4199V46	KS-E34
D-valve & X-valve (6000)									
Not Used	1 1/8"	N/A	N/A	N/A	N/A	12A 4200A0905	ME25S290	12A 4199V39	KS-B25/E25
Kramer Air cooled condenser - HDD-101 (Normally Open)	7/8"	N/A	N/A	N/A	N/A	12A 4200A0704	OE25S290	12A 4199V44	KS-OB25/OE25
D-valve & X-valve (Early HEB-30's & HEB-40's)	7/8"	12A 4200A0701	RB21MS7	12A 4199V07	76754	N/A	N/A	N/A	N/A
X-valve (M2500, M3000 & M4000)									
D-valve & X-valve (HE-30's & HE-40's)	7/8"	12A 4200A0702	RB21ME7	12A 4199V07	76754	12A 4200A0705	ME25S270	12A 4199V39	KS-B25/E25
D-valve (Small machines before 1982)	7/8"	----	B6MS & B6MS7	12A 4199V06	76642	N/A	N/A	N/A	N/A
Kramer Air cooled condenser - HDD-61 (Normally Open)	5/8"	N/A	N/A	N/A	N/A	12A 4200A0503	OE14S250	12A 4199V42	KS-OB14/OE14
X-valve (HEB-10's)	5/8"	12A 4200A0501	RB15S5	12A 4199V05	76753	12A 4200A0501	MB19S2	12A 4199V43	KS-B19/E19
D-valve & X-valve (1500 & 1800)			(changed part to Sporlan)						
6000 & 9000 TXV conversion kit									
X-valve (HE-20's)	5/8"	12A 4200A0502	RB9ME5	12A 4199V02	76750	12A 4200A0504	ME14S250	12A 4199V38	KS-B14/E14
D-valve (early M1500's & M1800's)	5/8"	----	B4MS & B4MS5	12A 4199V04	76641	N/A	N/A	N/A	N/A
Flush valve & Compressor heads (24's & 34's)	3/4"	12A 4200A0602	GP607	N/A	N/A	12A 4200A0607	KBR246P1	12A 4199V48	KS-BR24
Flush valve (P18 - Used before vaccumm break valve)	3/4"	12A 4200A0603	12F23C2148ACF	N/A	N/A	N/A	N/A	N/A	N/A
A-valve (Small machines before 1982)	1/2"	----	B3MS4	12A 4199V01	76640	N/A	N/A	N/A	N/A
A-valve (Early HEB's)	1/2"	12A 4200A0402	RB9MS4	12A 4199V02	76750	N/A	N/A	N/A	N/A
A-valve (HE's)	1/2"	12A 4200A0403	RB9ME4	12A 4199V02	76750	12A 4200A0404	ME9S240	12A 4199V37	KS-B9/E9
A-valve & TC-valve (HE Lowside)	1/2"								
A-valve (P24F's & P24FL's)	1/2"	12A 4200A0401	200RB5S4-M (Alco)	12A 4199V49	KS30115				
Flush valve (P118F Crushed Ice)	3/8"	12A 4200A0302	201WB06P03 (Alco)	12A 4199V50	K1112	12A 4200A0303	W6P1	N/A	N/A
Vaccumm break (P18's & Von's)	1/4"	12A 4200A0202	04F2002118ACFGC	N/A	N/A	12A 4200A0203	EV1-3-NO (Danfoss)	N/A	N/A

Solenoid valve coils: Sporlan N.C. (MKC-2) - 12A2105C16
 Sporlan N.O. (OMKC-2) - 12A2105C04
 Jakes-Evens N.C. (R-23MM) - 126232RB

Allen-Bradley Compressor Motor/CC Contactor Wiring

12A7516E28 - 3 POLE W/1NO

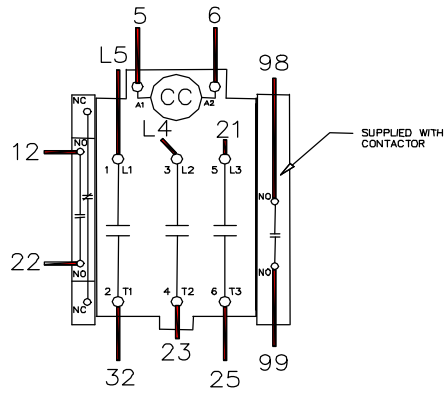

NOTE: REQUIRES 12A7518E30
1NO/1NC AUX CONTACT

B-SERIES HE

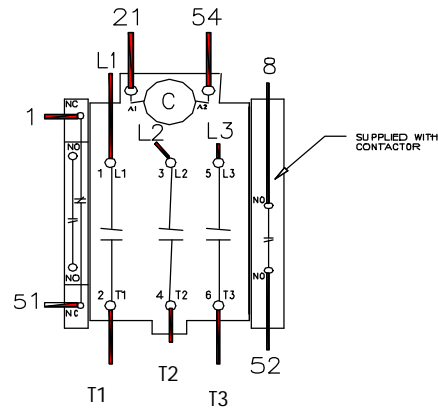

SUPPLIED WITH CONTACTOR

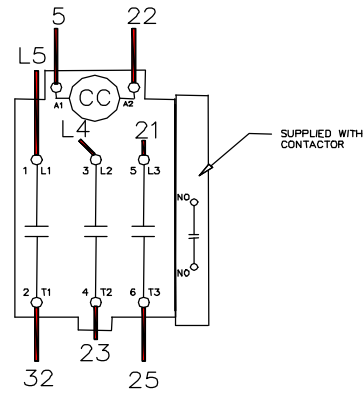

SUPPLIED WITH CONTACTOR

M-SERIES
R12

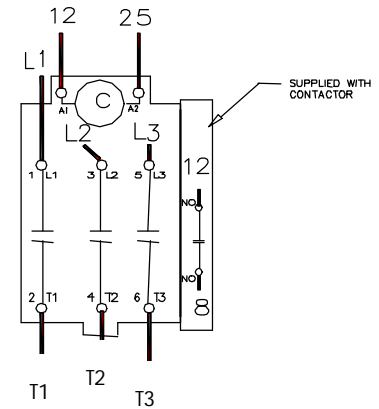

SUPPLIED WITH CONTACTOR

REPLACES 12A7516E05 (FURNAS) & 12A7516E17 (CUTLER-HAMMER)

CIRCUIT BREAKER CONVERSION

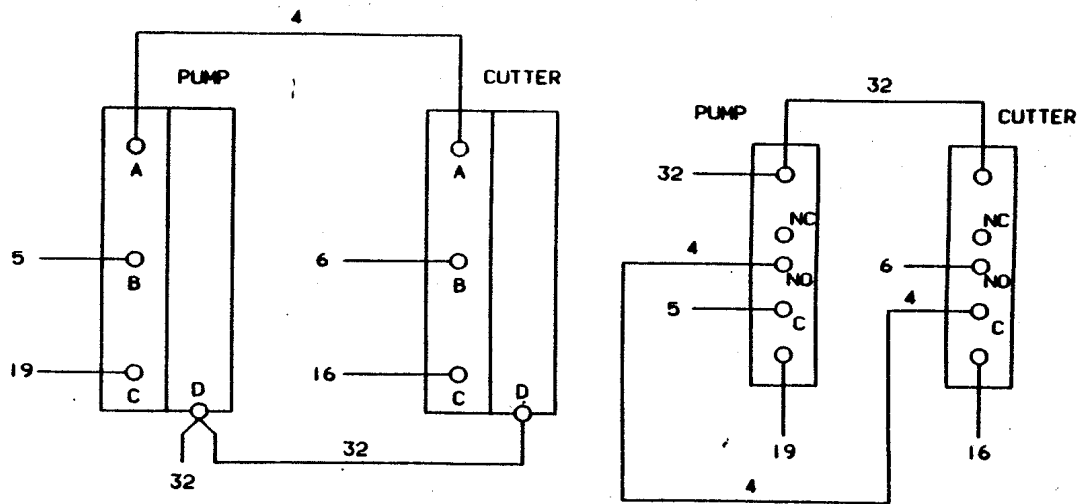
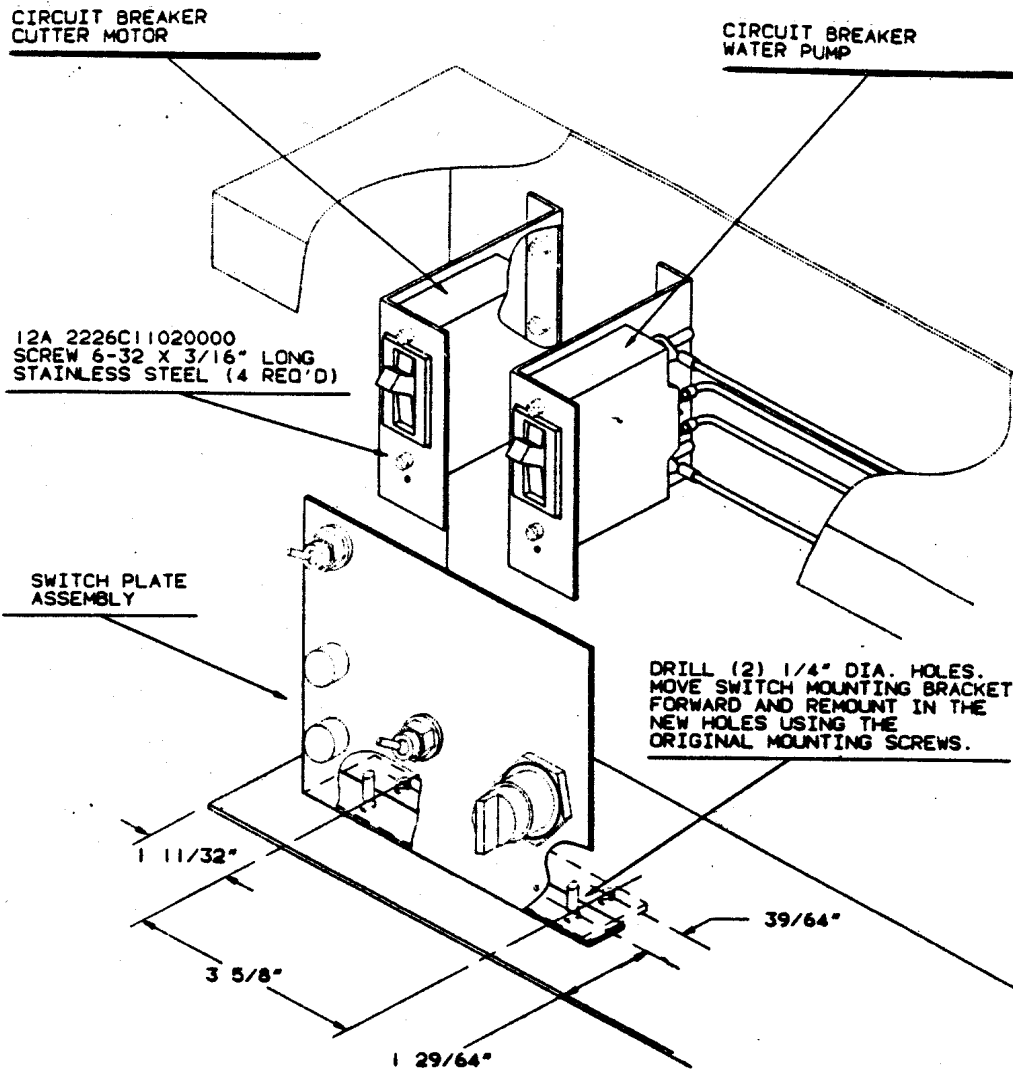

OLD BREAKERS

(VIEWED FROM REAR)

NEW BREAKERS

M1500 thru 4000 Control Panel Layout

Form 24T-13 - 2-91 - VOGT

CONTROL PANELS

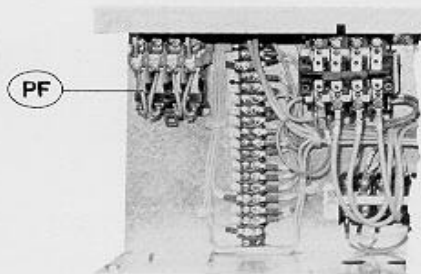
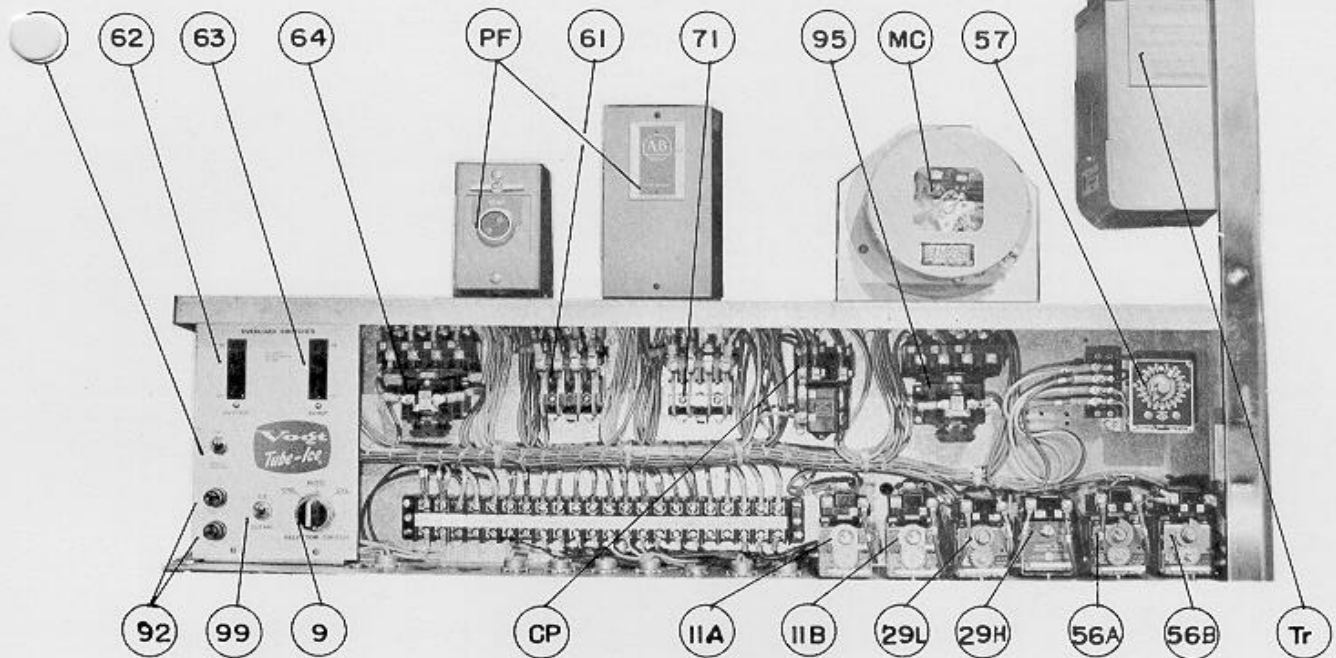

**MACHINE PANEL FOR
REMOTE CONTROLS**

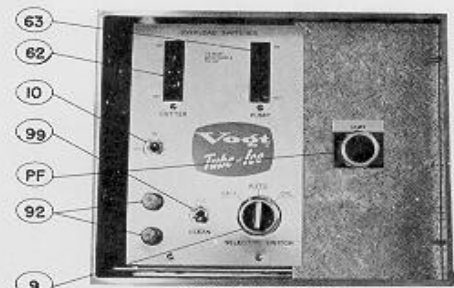

REMOTE CONTROLS

- | | |
|--|--|
| <p>9) SELECTOR SWITCH FOR PRODUCTION OF EITHER CYLINDER OR CRUSHED ICE.</p> <p>10) On-Off/Thaw Toggle Switch for manually starting, stopping and thawing machine.</p> <p>11) ICE BIN THERMOSTAT, for automatically stopping and starting the machine from the ice level in the storage bin (11A - Crushed Ice, 11B - Cylinder Ice.) For adjustment, see SERVICE MANUAL.</p> <p>29) SAFETY PRESSURE SWITCHES, to shut machine down in the event of unusual pressure condition (29L - Low Pressure Switch, 29H - High Pressure Switch.) For adjustment, see SERVICE MANUAL.</p> <p>56) FREEZER PRESSURE SWITCH, for regulating freezing period (56A - Crushed Ice, 56B - Cylinder Ice). For adjustment, see SERVICE MANUAL.</p> <p>57) THAWING TIMER (T), for regulating thawing period.</p> <p>61) RELAY (CR) FOR MAKING AND BREAKING VARIOUS CIRCUITS CONCERNED WITH FREEZING AND THAWING.</p> <p>62) CIRCUIT BREAKER (S1), FOR CUTTER MOTOR.</p> <p>63) CIRCUIT BREAKER (S2), FOR WATER PUMP MOTOR.</p> | <p>64) COMPRESSOR MOTOR CONTACTOR (C).</p> <p>71) REVERSING RELAY (R) FOR MAKING AND BREAKING VARIOUS CIRCUITS CONCERNED WITH FREEZING CYLINDER AND CRUSHED ICE.</p> <p>92) FUSES FOR COMPRESSOR CRANKCASE HEATER AND VARIOUS OPERATING COILS - BUSS AGC GLASS TYPE, 1 AMP., 250V., OR EQUAL.</p> <p>95) CONTROL CIRCUIT CONTACTOR (CC) FOR MAKING AND BREAKING CONTROL CIRCUIT.</p> <p>99) ICE-CLEAN TOGGLE SWITCH FOR MANUALLY SETTING CONTROLS FOR ICE-MAKING OR EQUIPMENT CLEANING OPERATION. SET SWITCH TO "ICE" POSITION FOR NORMAL ICE-MAKING. SEE "CLEANING PROCEDURE" FOR EQUIPMENT CLEANING INSTRUCTIONS.</p> <p>MC) MERCURIO CONTROL FOR CONDENSER FAN (AIR COOLED MACHINES ONLY).</p> <p>CP) CONDENSER FAN MOTOR CONTACTOR (AIR COOLED MACHINES ONLY).</p> <p>PF) POWER FAILURE RELAY (WHEN SUPPLIED).</p> <p>TR) TRANSFORMER (WHEN REQUIRED).</p> |
|--|--|

Wiring Diagrams for 1/2HP Cutter Motor (Single Phase)

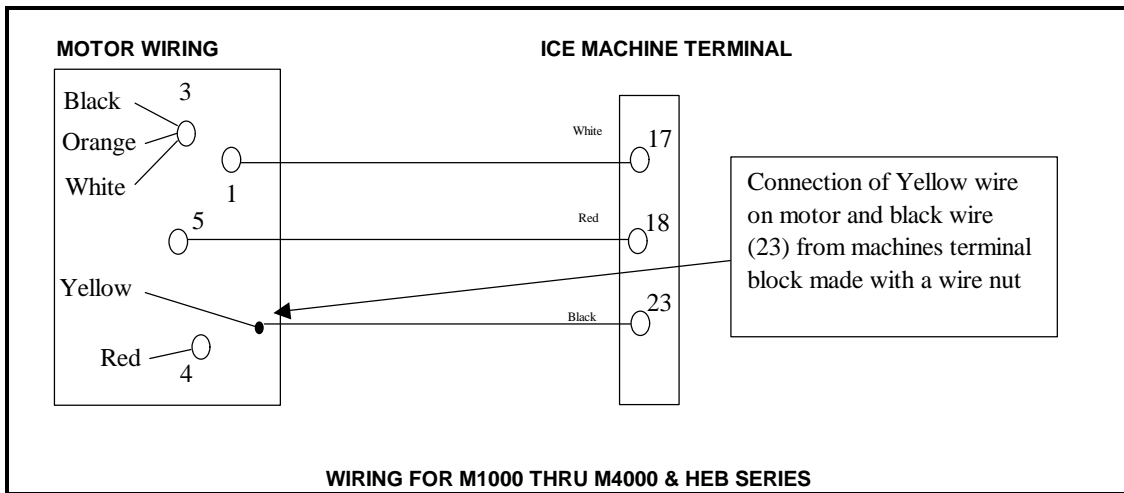
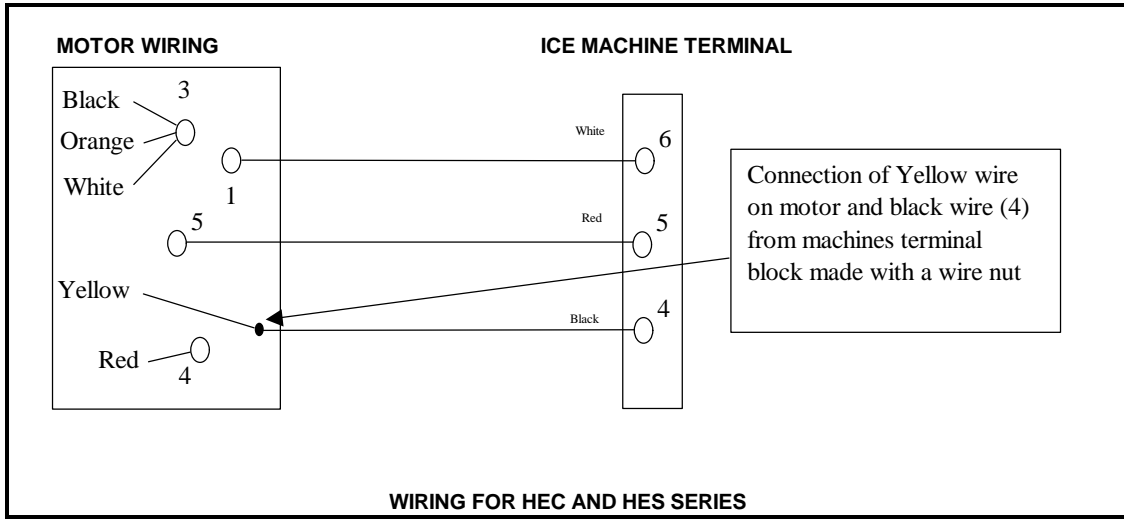

THAWING TIMER WIRING INSTRUCTIONS

Part # 12A7503E22

1sec to 100hrs

24-240VAC, 50/60hz, delay on make timer, DPDT

8 pin plug-in timer

Note: Timer Base #: 12A7503E2201

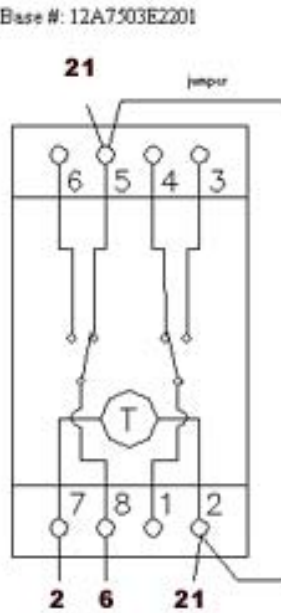

HE B-Series

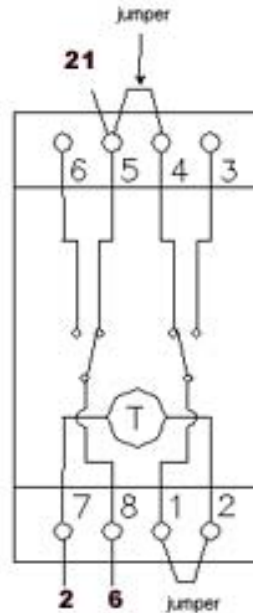

M1500-M9000 Series (R-12)

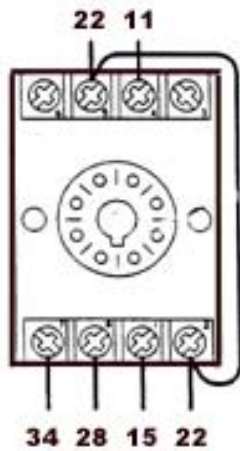

P118F
(B-Series)

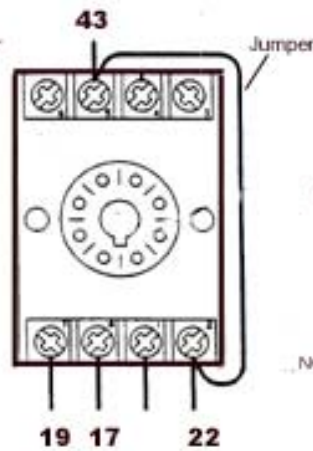

P24-P34

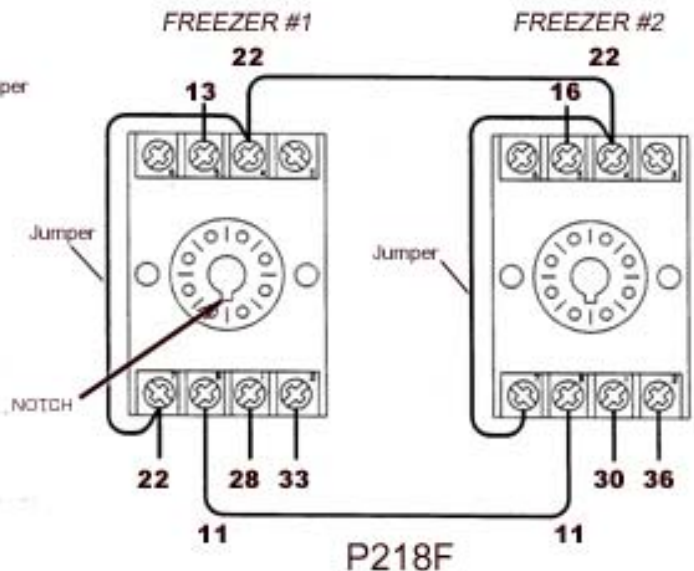

NOTES: MAKE SURE NOTCH IS POINTING DOWNWARD
USE JUMPER ONLY IF PREVIOUS TIMER HAD JUMPER

12A7503E22 - Harvest / Thaw Timer (Delay on Make)



Power Light (green)
 Light blinks while "timing"
 Light solid when "timed out"

Harvest Time adjustment dial
 Set between 2 and 3 (min)
 Note: If more than 3 minutes required, change Range to 0-12

Up Light (red)
 Light off while "timing"
 Light solid when "timed out"



Time Range adjustment
 0 - 1.2
 0 - 3
 0 - 12
 0 - 30

Unit adjustment
 sec
 min
 hrs
 10h



Allen-Bradley - 100-240VAC, 50/60hz, Delay on make timer, DPDT
 Part # 700-HRM12TA17

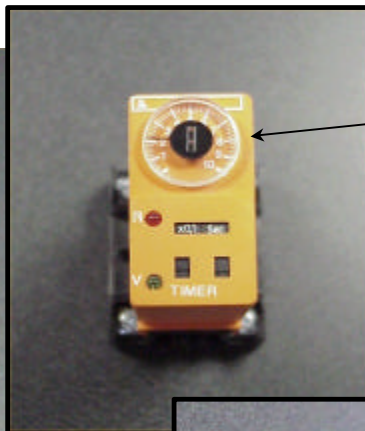
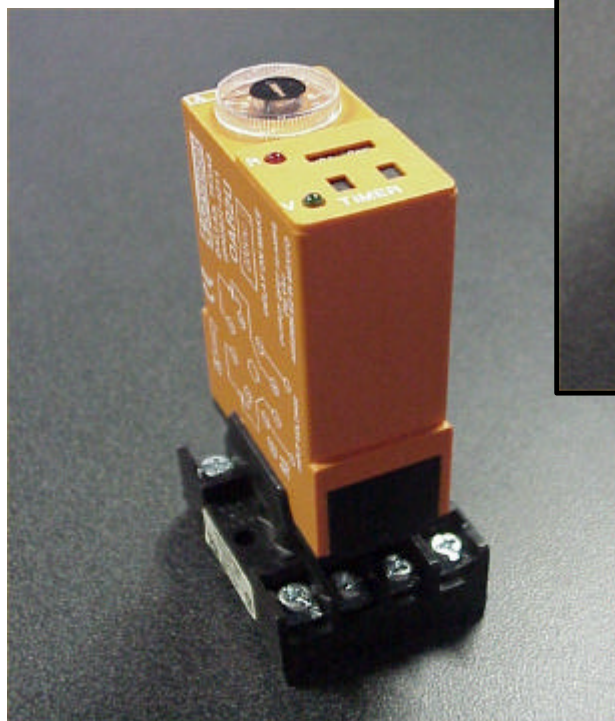

Harvest Time adjustment dial
Set between 2 and 3.5 (min)

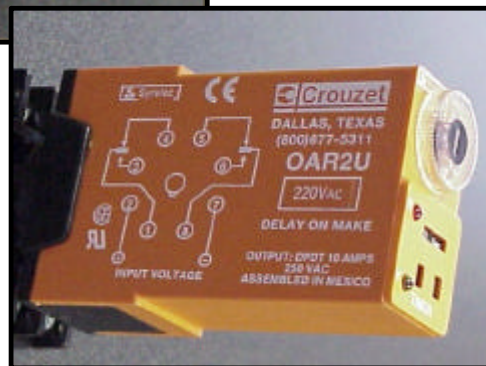

Old Crozet version - 220VAC & 110VAC, 50/60hz, Delay on make timer, DPDT

Part #: OAR2U 220A (220VAC version)

Part #: OAR2U 110A (110VAC version)



Harvest Time adjustment dial
Set between 2 and 3.5 (min)

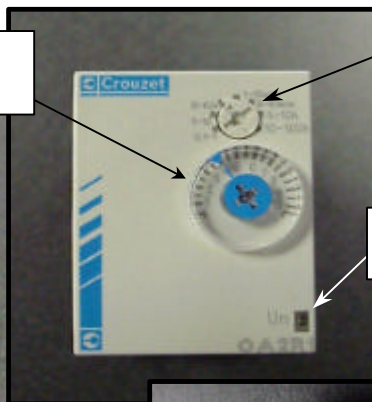

Time Range
Set on 1-10min

Light blinks while "timing"
Light solid when "timed out"



New Crozet Version - 24-240VAC, 50/60hz, Delay on make timer, DPDT

Part # 88 887 215

Note: New timer is a direct replacement; wiring and operation are same

Allen-Bradley Thermostat Setting

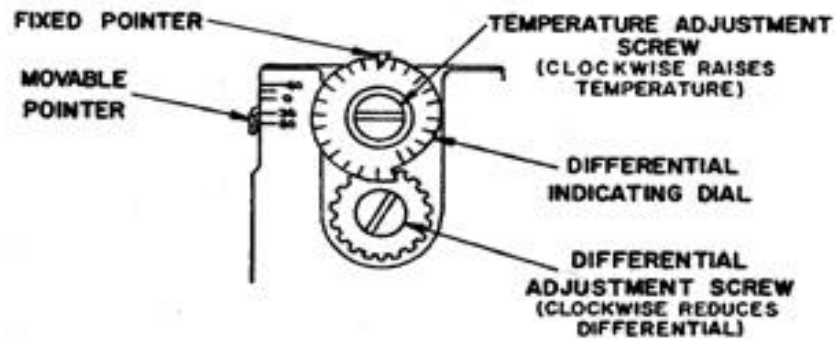

The ice bin thermostats are set prior to shipment; however, a minor adjustment may be required due to local conditions after installation. The following procedure should be followed for initially setting or making adjustments to the ice bin thermostat.

1. Turn "Differential Adjustment Screw" clockwise until fixed pointer is at valley of "Differential Indicating Dial".
2. With bulb covered with ice, turn "Temperature Adjustment Screw" counter-clockwise until contacts on top of thermostat (between back and front right terminal) close.
3. Then turn "Temperature Adjustment Screw" in opposite (clockwise) direction, slowly, until the said contacts just open. Then continue turning screw in same direction 2 complete turns.
4. Remove ice from bulb. Warm bulb by holding in hand until contacts close. Turn "Differential Adjustment Screw" counter-clockwise until "Fixed Pointer" is at high part of dial.
5. Then, with bulb again covered with ice, turn "Differential Adjustment Screw", clockwise, slowly, until contacts just open. Continue same direction, two (2) additional divisions of cam dial.
6. Check the temperature around the bulb to assure that contacts close at 42-44°F.

To raise the temperature setting at which the machine will start up, turn "Temperature Adjustment Screw" clockwise. This means that more ice will have to be removed from the bin before the machine will start. NOTE - This adjustment will also raise the shut-off temperature which means that the machine will shut off with a lower ice level in the bin.

To raise only the temperature setting at which the machine will shut off, turn "Differential Adjustment Screw" clockwise. This rotates the "Differential Indicating Dial" counter-clockwise. Change setting only one division of the dial at a time.

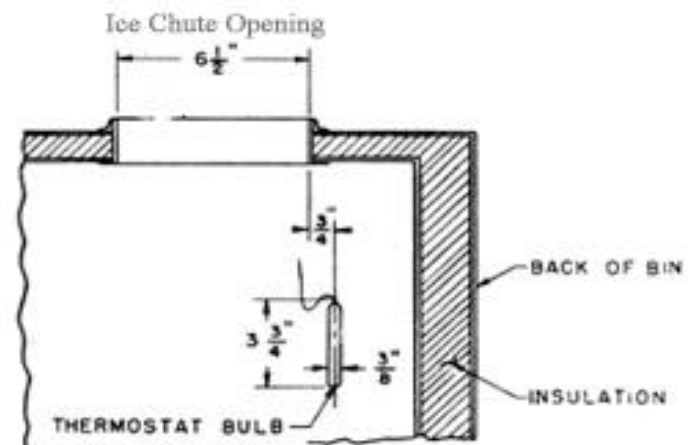

Thermostat Bulb Installation

HENRY VOGT MACHINE CO.
LOUISVILLE, KENTUCKY
TUBE-ICE DIVISION

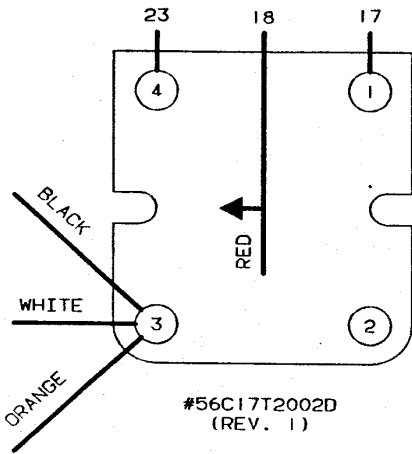
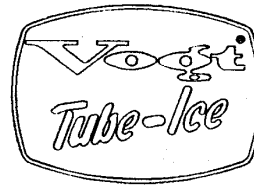

#56C17T2002D
(REV. 1)

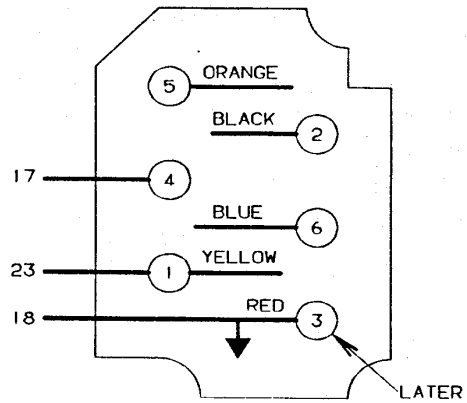

#56C17T2002F
(REV. 2)

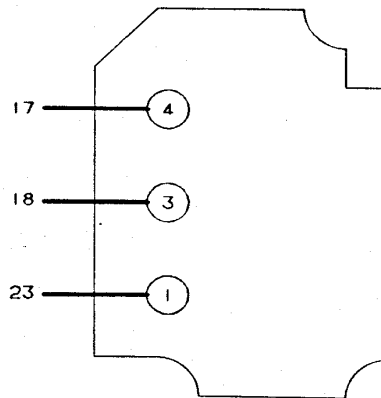

YVK #56C17D1238A (REV. 3)
YVK #56C17D1238B (REV. 4)

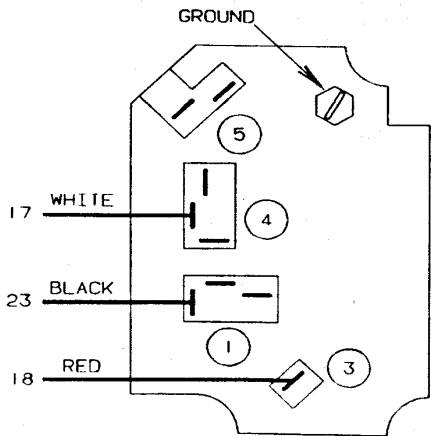

ZVN #56C17D1238B (REV. 5)
50/60HZ

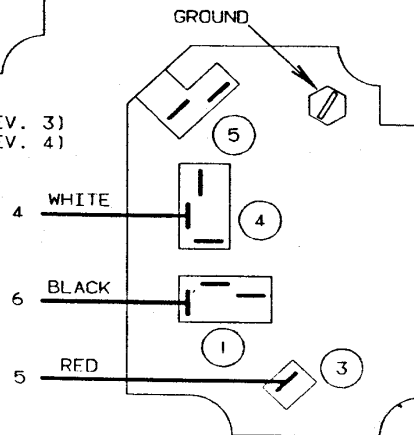

ZVN #56C17D1238B (REV. 6)
50/60HZ

MARATHON 1/4 H.P.
CUTTER MOTOR WIRING

LOGSDON
01/31/95

Allen-Bradley Reversing Relay/CR Relay Wiring

12A7516E43 – 2NO/2NC MOTOR RATED CONTACTS

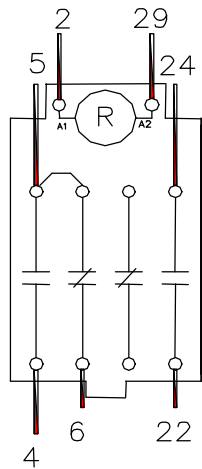

C-SERIES
HE

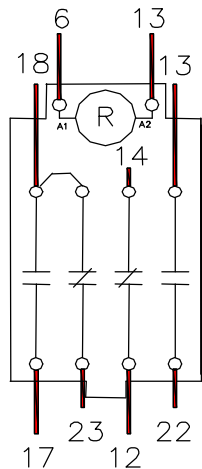

B-SERIES HE &
M-SERIES R12

REPLACES 12A7517E08 (POTTER-BRUMFIELD), 12A7517E15 (FURNAS)
& 12A7517E18 (CUTLER-HAMMER)

12A7516E43 – 2NO/2NC MOTOR RATED CONTACTS

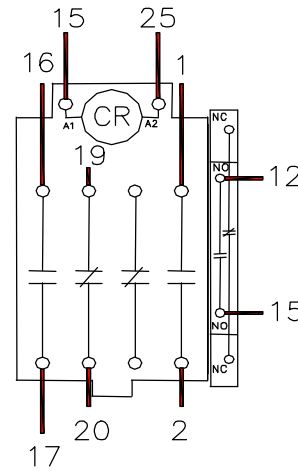

B-SERIES HE &
M-SERIES R12

NOTE: REQUIRES 12A7518E30
1NO/1NC AUX CONTACT

REPLACES 12A7517E16 (FURNAS) & 12A7517E20 (CUTLER-HAMMER)